

# 5000.0812K3M Low Profile DATA SHEET



## KIT CONTAINS

UNIDRAIN GLASSLINE UNIT WITH  
INTEGRATED GLASS CHANNEL  
LOW PROFILE OUTLET  
HIGHLINE FRAME  
HIGHLINE PANEL  
GLASS SCREEN

## 5002.0812 | 5003.0812 Glassline Module

For right-aligned shower screen

For left-aligned shower screen



### ITEM NUMBER R

5002.0812

### ITEM NUMBER L

5003.0812

## Specifications

<b>MATERIAL</b>	<b>SURFACE</b>	<b>FLOORING</b>
1,5 mm stainless steel (AISI 304)	Pickled	Tiles
<b>MEMBRANE</b>	<b>FLOOR CONSTRUCTION</b>	<b>INSTALLATION WIDTH (A)</b>
Liquid or sheet membrane	Concrete/wood	801 mm
<b>INSTALLATION DEPTH (B)</b>	<b>CENTRE (C)</b>	<b>SHOWER SCREEN SIZE (D)</b>
1301 mm	401 mm	1200 mm

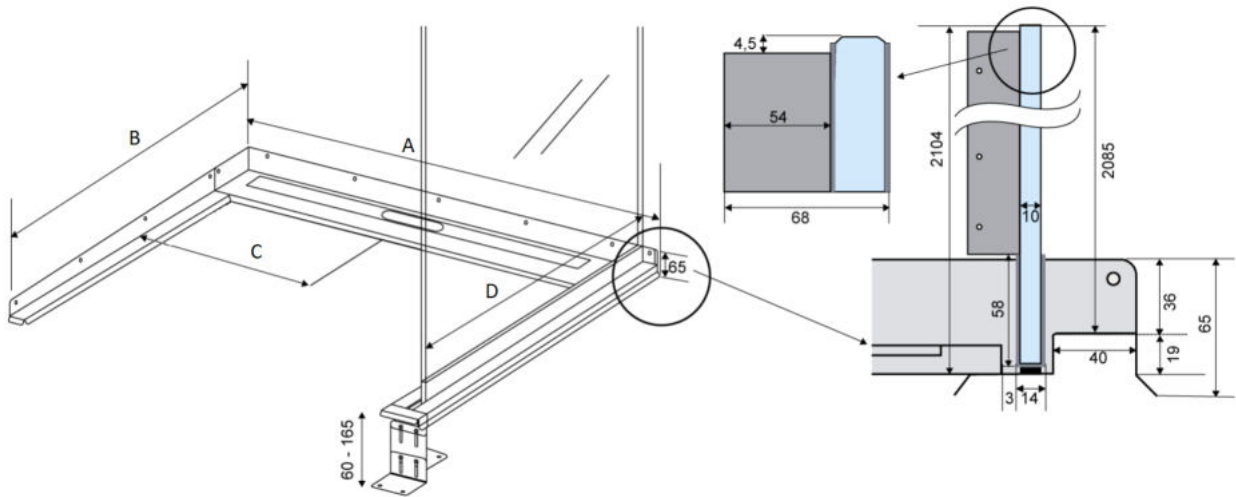

## 1417.0050 - Low Profile Outlet

Linear 1417.0050

Ø 50 mm horizontal drain

The odour barrier can be removed for cleaning

Can be rotated 180 degrees if a rear-facing outlet is required

Note: Odour barrier is VA-approved



### Specifications

ITEM NUMBER	GTIN NUMBER	WEIGHT INCLUDING PACKAGING
1417.0050	5707692007915	500 g
WEIGHT EXCLUDING PACKAGING	MATERIAL	USAGE
350 g	Plastic (PP)	Line drain
BARRIER	GASKET	CAPACITY
With (odour barrier)	EPDM	0.6 l/s
SIDE INLET	CENTER	FITS DRAIN UNIT
Without	30 mm	1001, 1002, 1003, 1004, 1100, 3002, 3004, 5002, 5003, 4004

FITTING HEIGHTS - LINE FAUCETS 1001, 1002, 1003, 1004

Ø	Outlet direction	300	600	700	800	900	1000	1200
Ø 50 mm	Horizontal	64 mm	68 mm	69 mm	70 mm	71 mm	72 mm	74 mm

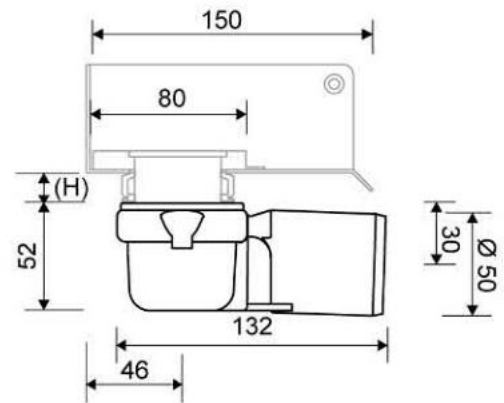

## 1910.0815 - 800mm Stainless Steel Frame

Line 1910

Highline Frame can be placed around Highline Custom, Cassette and Panel.  
Also available in 10, 12 and 25mm heights (depending on the thickness of the floor tile)  
Contact Wetroom Materials for other heights.

Must be installed before tiling.



### Specifications

ITEM NUMBER	GTIN NUMBER	WEIGHT INCLUDING PACKAGING
1910.0815	5707692004389	2140 g
WEIGHT EXCLUDING PACKAGING	MATERIAL	USAGE
2060 g	Stainless steel (AISI 304)	Line drain
SURFACE	INSTALLATION LENGTH (L)	HEIGHT (H)
Brushed	795 mm	H 15 mm
LENGTH MODEL	FITS DRAIN UNIT	INSERT
800 mm	1001, 1002, 1003, 1004, 1100, 5002, 5003	Synthetic



## 1920.0800 - 800mm Panel

### HighLine | Panel

The set consists of a Highline Panel in Brushed Stainless Steel, heightener set and screws.  
Can be used with or without Highline Frame.

When using without Highline Frame, ensure rear wall build up allows for equal drainage gap on all sides.  
Also available in Black, Brass, Copper and Polished Stainless Steel



### Specifications

ITEM NUMBER	GTIN NUMBER	WEIGHT INCLUDING PACKAGING
1920.0800	5707692004501	2300 g
WEIGHT EXCLUDING PACKAGING	MATERIAL	USAGE
2230 g	Stainless steel (AISI 304)	Line drain
SURFACE	LENGTH MODEL	HEIGHTENER SET
Brushed	800 mm	Plastic (PE)
LENGTH WITH/WITHOUT FRAME		
733/795 mm		



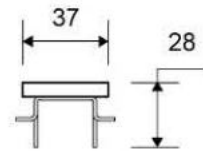
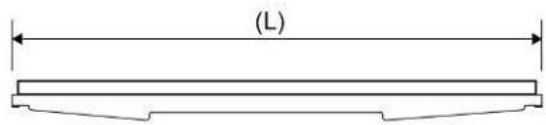
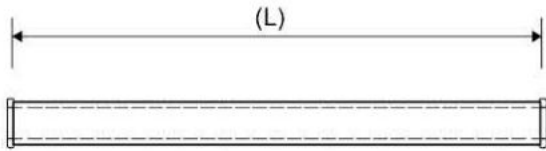

## 5100.1200

GlassLine | Right and left-aligned shower screen

Design: Transparent

10 mm safety glass

No visible screws or fittings in the finished result

The glass surface is treated with Cleantec nanotechnology, making it water-repellent, less susceptible to limescale and easier to clean.



### Specifications

<b>ITEM NUMBER</b>	<b>LENGTH MODEL</b>	<b>HEIGHT (H)</b>
5100.1200	1200 mm	2104 mm
<b>DESIGN</b>	<b>MATERIAL</b>	
Transparent	Stainless steel (AISI 304) 10 mm safety float glass	

